

User Manual

APEX PRO



Please familiarize yourself with the user manual.

Improper use of the device may result in its malfunction and pose a danger to the user.

TABLE OF CONTENTS

1. INTRODUCTION	3
2. SAFETY	4
3. STRUCTURE AND COMPONENTS OF THE DEVICE	5
3.1. Front view	5
3.2. Rear view	6
3.3. Dome	7
3.4. Camera Arm (Magic-Arm) and Laparoscopic Camera	8
4. ASSEMBLY AND START-UP OF THE TRAINING STATION	9
4.1. Preparation	9
4.2. Monitor Assembly	9
4.3. Cables connection	10
4.4. Assembly within the Dome	11
4.5. Mounting the Laparoscopic Camera	13
4.6. Connecting the Laparoscopic Camera to the Training Station	14
4.7. Preparing Training Tools and Modules	16
5. WORKING WITH THE DEVICE	18
5.1. Powering On the Station	18
5.2. Ergonomic adjustments	18
5.3. Correct operation of training analysis	19
5.4. Training Modules	20
5.5. Laparoscopic Camera	21
5.6. Laparoscopic instruments	24
6. PRECAUTIONS AND MAINTENANCE	26
7. TERMS OF WARRANTY	27
8. TECHNICAL DATA	28

1. INTRODUCTION

The Apex PRO is a training station designed for the development of laparoscopic skills. The device was created by the team of mechanical, electronic, and software engineers at Laparo Medical Simulators.

The educational and simulation value has been prepared in collaboration with professional surgeons. The Apex PRO offers both the possibility of training with physical training modules and virtual procedure simulations, referred to as a hybrid approach. Additionally, the Apex PRO can be equipped with pediatric training scenarios.

While using the device, users are guided step by step through a wide range of training scenarios and laparoscopy theories.

2. SAFETY

- The device is intended for adult users only.
- The device must be stored in a place inaccessible to children – it is not a toy.
- Use of the device is prohibited if it is damaged or not functioning properly.
- Maintenance, assembly, and repair work should be entrusted to an authorized service center.
- In case of fire, do not extinguish it with water.
- Touching electrical contacts and inserting foreign objects into them is prohibited.
- The cables entering the station must be arranged in a way that prevents tripping hazards.
- The training station contains a high-power endoscopic light source. Exercise extreme caution when the light is on. The beam of light emanating from the light guide can cause eye injury. There is also a risk of burns as the beam of light exiting the light guide is highly concentrated. The replacement of the laparoscope in the camera should only be done when the light source is turned off. If the light guide is not attached to the laparoscope, it can cause a fire if the light beam encounters flammable material.
- The training station contains Class 1 laser devices (electronic trocars).
- Caution: be careful when using laparoscopic tools – for example, laparoscopic needles and scissors can pose a danger. Lack of attention and leaving them unsecured may lead to injury.
- The device can be safely disconnected from the electrical network by unplugging the power cord after it has been turned off.
- After the period of use, it should be disposed of in accordance with the guidelines and laws of the respective region or country. It should not be disposed of in municipal waste.
- The manufacturer is not responsible for the operation of the device if it has been modified in any way by the user.
- The initial setup and installation must be carried out by qualified technical personnel in accordance with the manufacturer's instructions.
- Only accessories provided or approved by the manufacturer may be used in the simulator (camera, laparoscopic tools, training modules, and others).
- The device features an automatic positioning mechanism for training modules. Caution should be exercised during its use.
- The mechanism will automatically activate at the start of the training and position the training module correctly. Before commencing the training, remove your hands from the training area and ensure that no unnecessary objects are present.
- Exercise particular caution when the mechanism inside the training area is in motion:
 - Do not insert hands, fingers, or any other objects around the mechanism, and do not touch it;
 - Do not leave any unnecessary objects inside the training area.
- Do not attempt to open the training doors manually – use the opening button for this purpose.

3. STRUCTURE AND COMPONENTS OF THE DEVICE

3.1. Front view

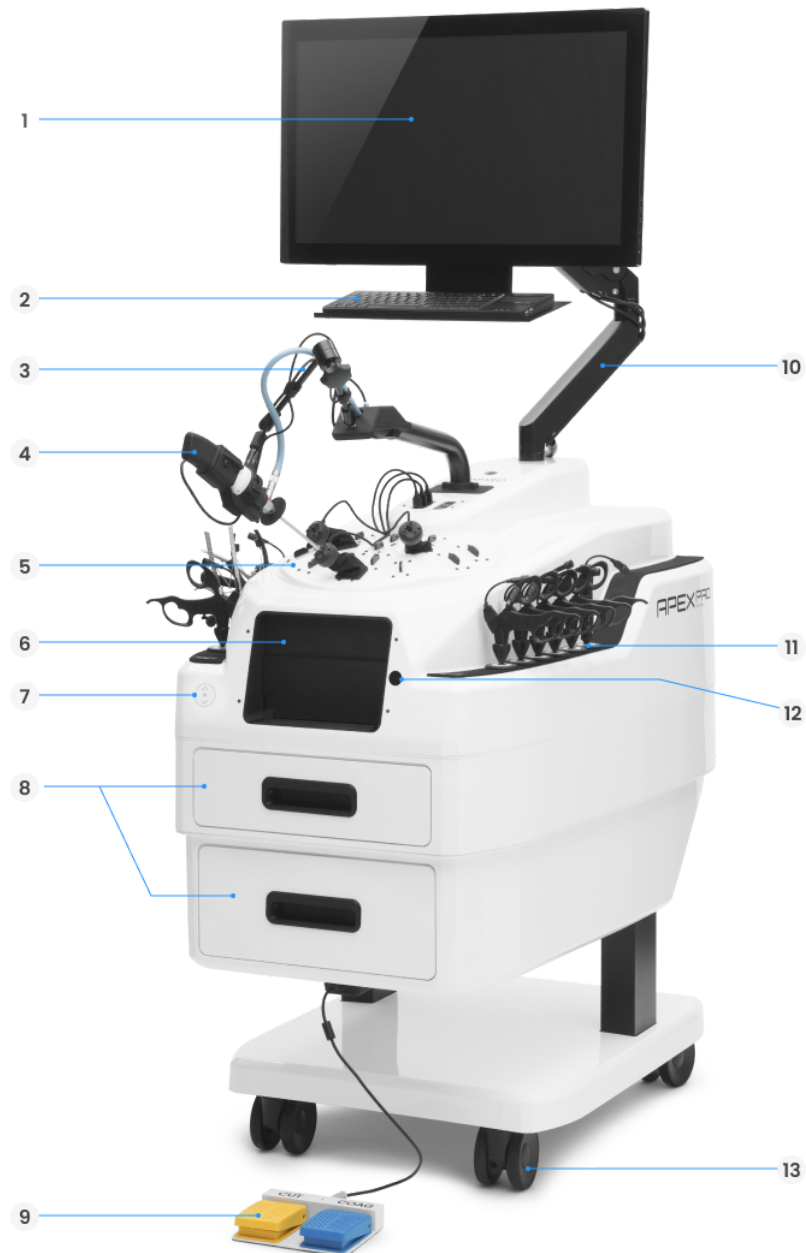

- | | |
|---|--|
| 1. Touchscreen monitor | 8. Storage drawers |
| 2. Keyboard with touchpad | 9. Foot switches for diathermy |
| 3. Magic-Arm camera fixation (dets. p. 8) | 10. Monitor arm |
| 4. Laparoscopic camera (dets. p. 8) | 11. Laparoscopic instruments |
| 5. Dome (dets. p. 7) | 12. Training area doors opening button |
| 6. Training area doors | 13. Break-locking wheels |
| 7. Height adjustment switch | |

3.2. Rear view

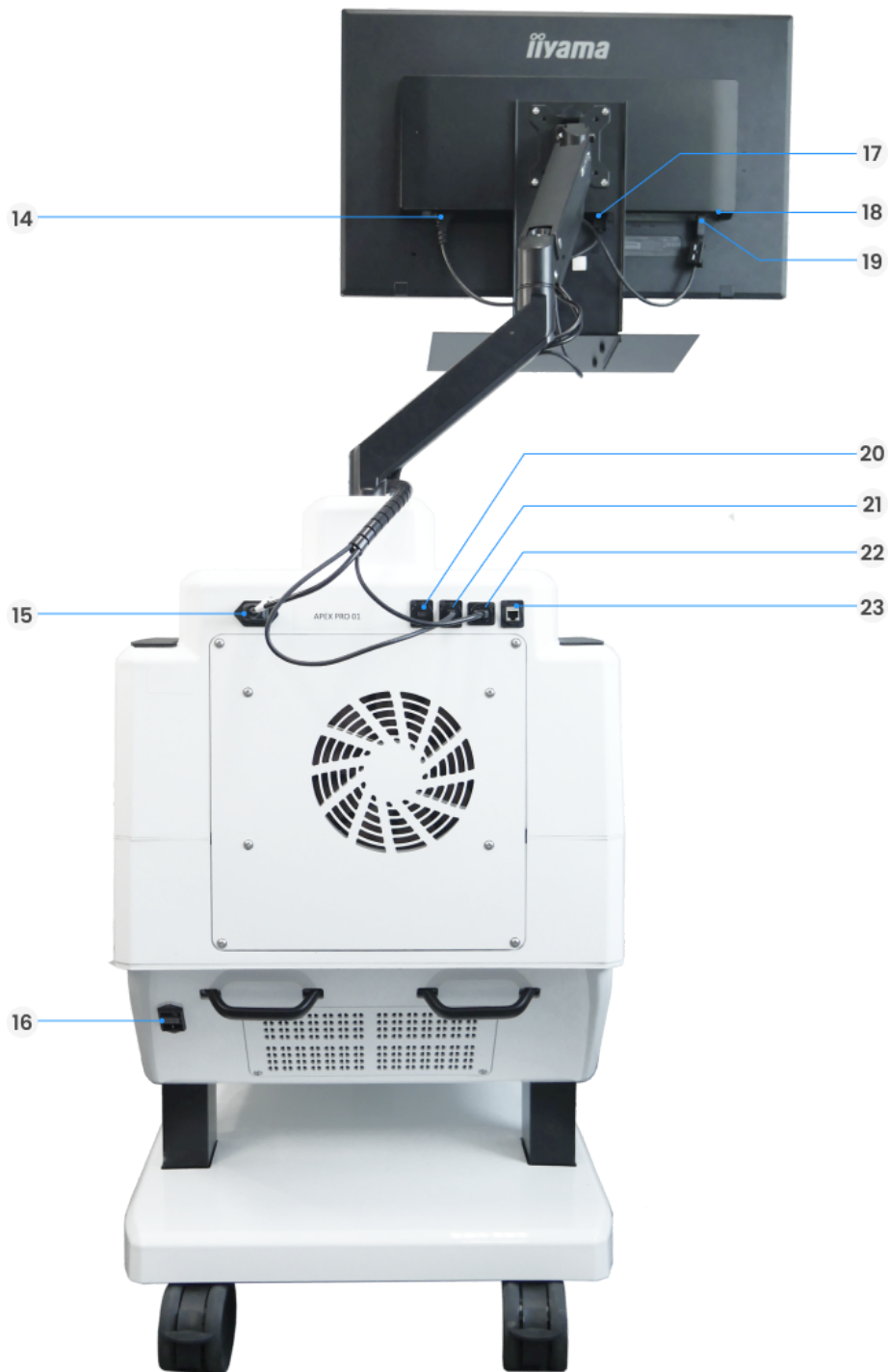

- 14. Monitor power socket (monitor side)
- 15. Monitor power socket (station side)
- 16. Main station power socket
- 17. DisplayPort socket (monitor side)
- 18. Keyboard USB slot

- 19. Monitor USB port (monitor side)
- 20. Additional DisplayPort socket
- 21. DisplayPort socket (station side)
- 22. Monitor USB port (station side)
- 23. Ethernet socket

3.3. Dome



- 24. Trocar controller
- 25. Camera USB port
- 26. On/off button
- 27. Instruments HUB

- 28. USB HUB for trocar controllers
- 29. Removable dome
- 30. Port cover plates / port locations
- 31. Instrument storage slots

3.4. Camera Arm (Magic-Arm) and Laparoscopic Camera

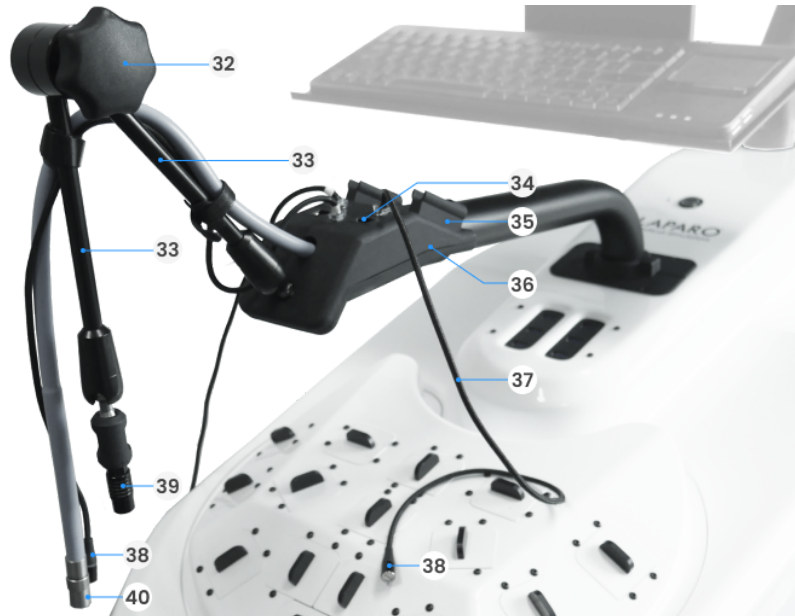

- | | |
|---|-----------------------------|
| 32. Magic-Arm knob | 37. Magnetic cable |
| 33. Magic-Arm camera fixation | 38. Magnetic connector |
| 34. Instruments HUB socket | 39. Magic-Arm Quick-Release |
| 35. Storage place for 3 mm trocar reducer | 40. Optical fiber |
| 36. Instruments HUB | |

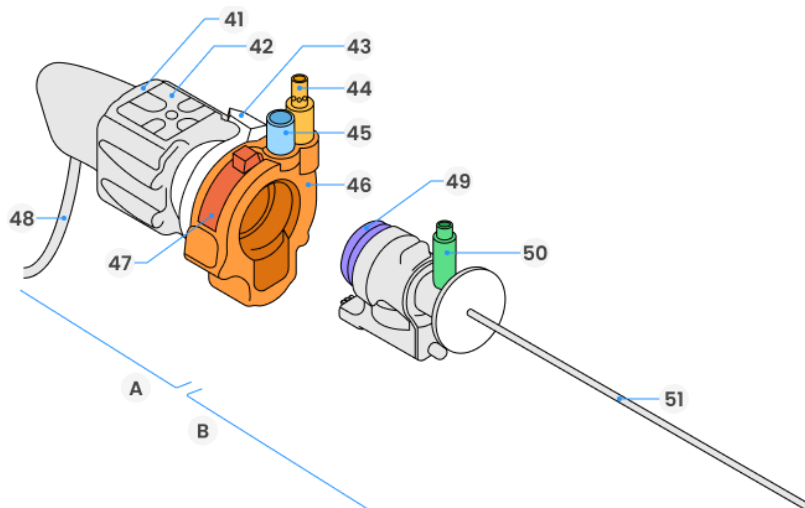

A - Camera

- 41. Camera arm
- 42. Functional buttons
- 43. Focusing ring
- 44. Camera Quick-Release
- 45. Magnetic socket
- 46. Ocular coupler
- 47. Ocular Quick-Release
- 48. USB Cable

B - Laparoscope

- 49. Ocular
- 50. Optical fiber socket
- 51. Shaft

4. ASSEMBLY AND START-UP OF THE TRAINING STATION

4.1. Preparation

- 4.1.1. The training station should be placed on a flat surface. Use the wheel locks (see page 5 - fig. 3.1, item 13) by pressing the button on each wheel.

4.2. Monitor Assembly

- 4.2.1. Place the monitor arm (**A**) (see page 5 - fig. 3.1, item 10) on the training station, then tighten the locking screw (**B**). The screw should be tightened until resistance is felt.

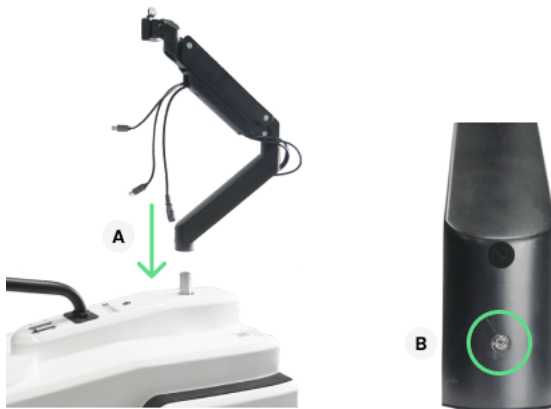

- 4.2.2. Mount the touchscreen monitor (see page 5 - fig. 3.1, item 1) on the monitor arm (see page 5 - fig. 3.1, item 10). Slide the monitor onto the monitor arm holder (**A**). When disassembling, simply press the release trigger at the holder (**B**) and lift the monitor upwards.

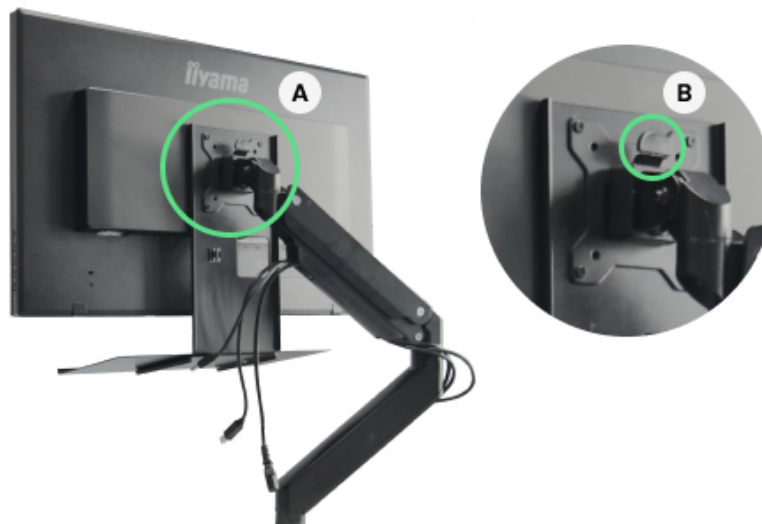

4.3. Cables connection

- 4.3.1. Connect the cables between the monitor arm and the monitor: power cable (**A**), DisplayPort (**B**), and USB (**C**) (see page 6 - fig. 3.2, items 14, 17, 19).



- 4.3.2. Connect the cables between the monitor arm and the station: power cable (**A**), DisplayPort (**B**), and USB (**C**). Also, connect the main power cable (**D**) (see page 6 - fig. 3.2, items 15, 21, 22, 16).

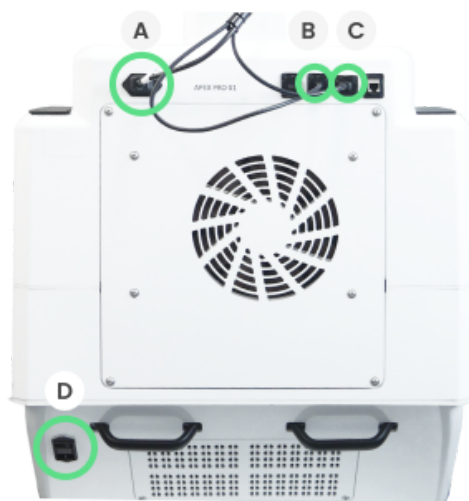

- 4.3.3. Place the keyboard on the base under the monitor and connect the USB cable to the port at the back of the monitor (see page 6 - fig. 3.2, item 18).



- 4.3.4. Connect the foot switches for diathermy (see page 5 - fig. 3.1, item 9) to the USB port located under the station.

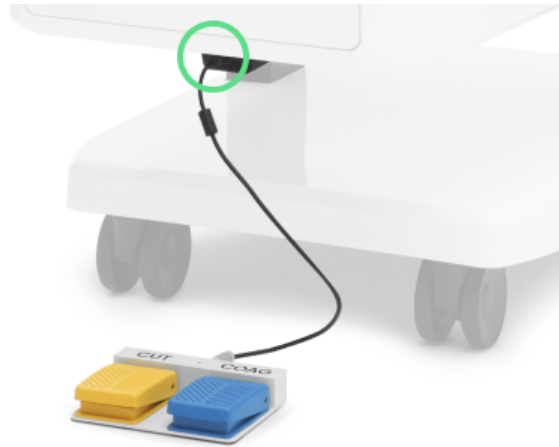

4.4. Assembly within the Dome

4.4.1. Prepare:

- 3 electronic trocars (see page 7 - fig. 3.3, item 24),
- 3 magnetic cables (see page 8 - fig. 3.4, item 37).

- 4.4.2. Remove the port cover plates from ports 1, 7, and 9 (see page 7 - fig. 3.3, item 30).

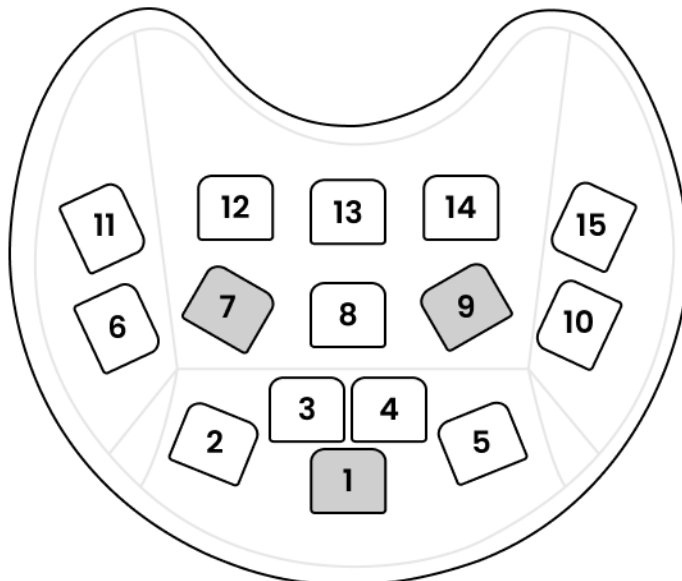

- 4.4.3. Place electronic trocars (**A**) in ports 1, 7, and 9. Pay attention to the shape of the trocar base and the port. Each trocar connects to the port using built-in magnets. Connect the trocar cables to the USB hub (**B**) (see page 7 - fig. 3.3, item 28).

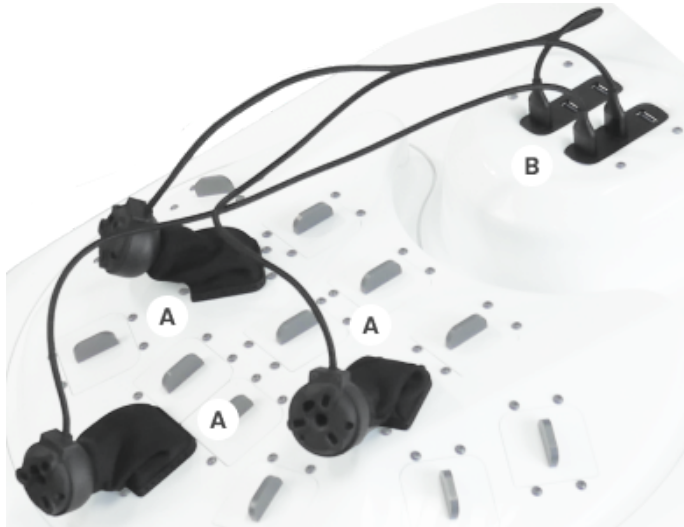

- 4.4.4. Connect 3 magnetic cables to the Instrument HUB (see page 7 - fig. 3.3, item 27).

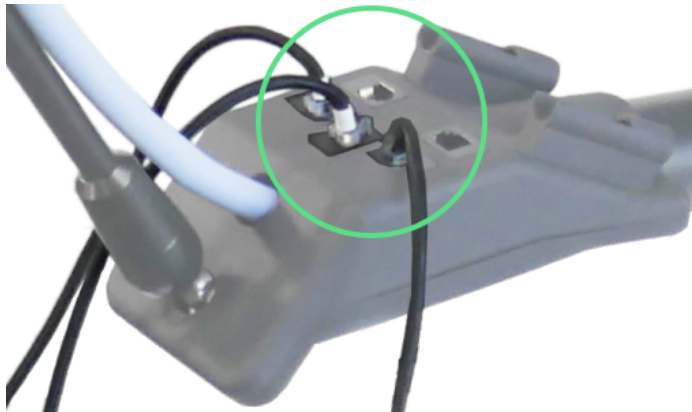

4.5. Mounting the Laparoscopic Camera

4.5.1. Prepare:

- camera (see page 8 - fig. 3.4, item A),
- laparoscope (see page 8 - fig. 3.4, item B).

The most commonly used optics in this training station is the 30° optics.

- ### 4.5.2.
- Remove the protective cover from the ocular coupler (**A**) by turning the lock (**B**), as well as two protective covers from the laparoscope - from the coupler (**C**) and the distal end of the shaft (**D**) (see page 8 - fig. 3.4, items 46, 47, 49, 51).

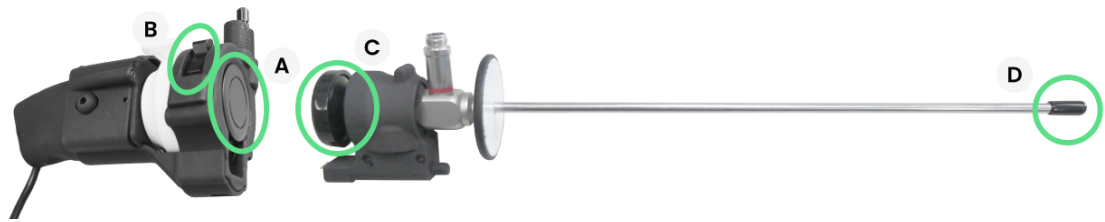

- ### 4.5.3.
- Rotate and hold the lock on the camera (**A**), insert the coupler into the camera coupler (**B**), and release the knob (**C**) (see page 8 - fig. 3.4, items 47, 49).

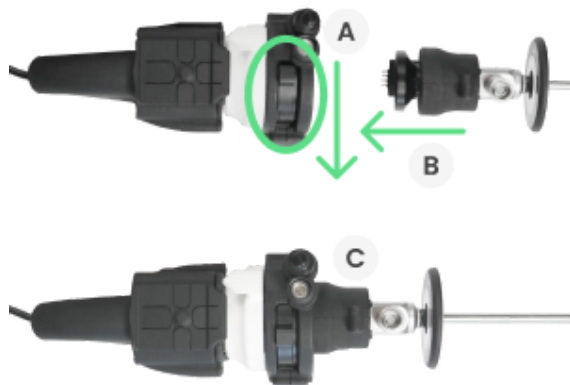

- ### 4.5.4.
- If you also have other optics (45°, 0°), you can place them in the upper storage drawer (see page 5 - fig. 3.1, item 8). Trainees will be able to independently exchange the laparoscope dedicated to specific scenarios. Details regarding the exchange of optics are in section 5.5.4. During the laparoscope change, pay special attention when unscrewing the light guide, as the light beam is highly concentrated. Ensure that the light source is turned off.

4.6. Connecting the Laparoscopic Camera to the Training Station

- 4.6.1. Any change in the position of the camera arm must be preceded by loosening the arm, i.e., by turning the camera arm knob (see page 8 - fig. 3.4, item 32).
- 4.6.2. All activities related to the assembly or replacement of the laparoscopic camera should be carried out with great caution.
- 4.6.3. Gently turn the camera arm knob **(A)** and position the camera arm by directing it downward (see page 8 - fig. 3.4, items 32 and 33). Tighten the knob to secure the arm **(B)**.



- 4.6.4. Grasp the quick-release lever of the camera arm (see page 8 - fig. 3.4, item 39) and pull it upward **(A-B)**, then place it over the camera quick-release and lower it **(C)** (see page 8 - fig. 3.4, item 44). A click will indicate a successful connection.

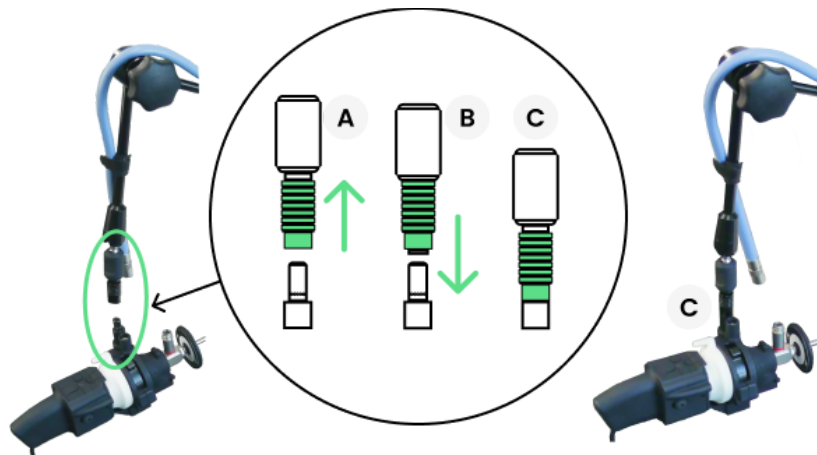

- 4.6.5. Loosen the camera arm knob to release the arm, insert the laparoscope into the trocar by about 5 cm, and tighten the knob.

- 4.6.6. Screw the optical fiber onto the laparoscope (see page 8 – fig. 3.4, items 40, 50).

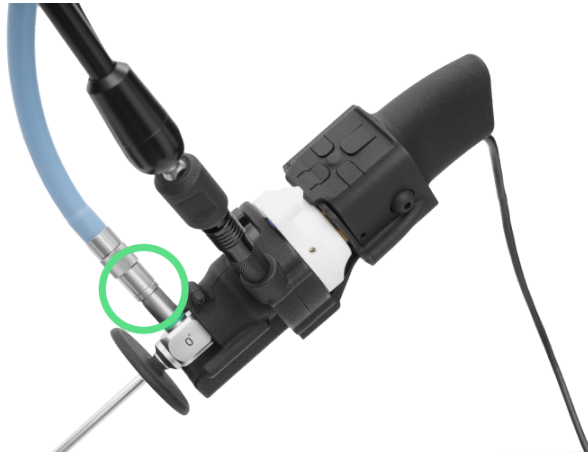

- 4.6.7. Attach the magnetic connector (A) to the camera (see page 8 – fig. 3.4, items 38 and 45), and connect the camera cable to the USB port (B) (see page 7 – fig. 3.3, item 25).



4.7. Preparing Training Tools and Modules

- 4.7.1. Place the instruments in the instrument storage slots (see page 7 - fig. 3.3, item 31).

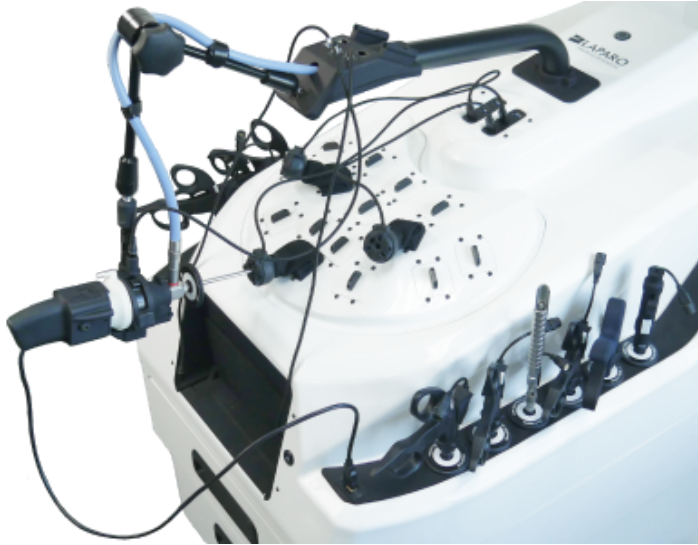

- 4.7.2. The training modules are located in the first and second drawers of the station (see page 5 - fig. 3.1, item 8). The first drawer is intended for physical modules for Laparo Training Program courses, while the second drawer is for procedural modules. If additional modules have been ordered, they are in a separate package.



- 4.7.3. Before pediatric scenario training, insert the reducer into the trocar opening. A click will indicate a successful connection.



- 4.7.4. The reducer should be removed each time the user wants to use 5 mm tools (standard instruments or Multi-Tools).
- 4.7.5. Place unused reducers in the storage place for 3 mm trocar reducer (see page 8 - fig. 3.4, item 35).

5. WORKING WITH THE DEVICE

5.1. Powering On the Station

- 5.1.1. Turn on the device using the power button (see page 7 - fig. 3.3, item 26) and wait for the login screen to appear. The Laparo computer application will start automatically.
- 5.1.2. The login and password for the application administrator are provided with the training station.
- 5.1.3. The application allows you to create accounts for each user. Accounts for instructors can only be created by the administrator, while accounts for trainees can be created independently.
- 5.1.4. A user who has his own account can take full advantage of the training station's capabilities (e.g. analysis of his own progress, learning curve or training history).
- 5.1.5. To learn more about creating accounts and possibilities for each user role (trainer, instructor, admin), go to the **HELP CENTER** section in the station's computer application.

5.2. Ergonomic adjustments

- 5.2.1. To adjust the height of the station, use the Height Adjustment Panel (see page 5 - fig. 3.1, item 7). Use the "up" and "down" buttons to set the optimal station height. The height of the station should be individually adjusted to the needs of each user.
- 5.2.2. The position of the Touch Monitor (see page 5 - fig. 3.1, item 1) is adjusted using two hands. Place the screen in front of the trainee, maintaining a distance of approximately 50 cm and the screen angle between 15° and 40° below the line of sight.

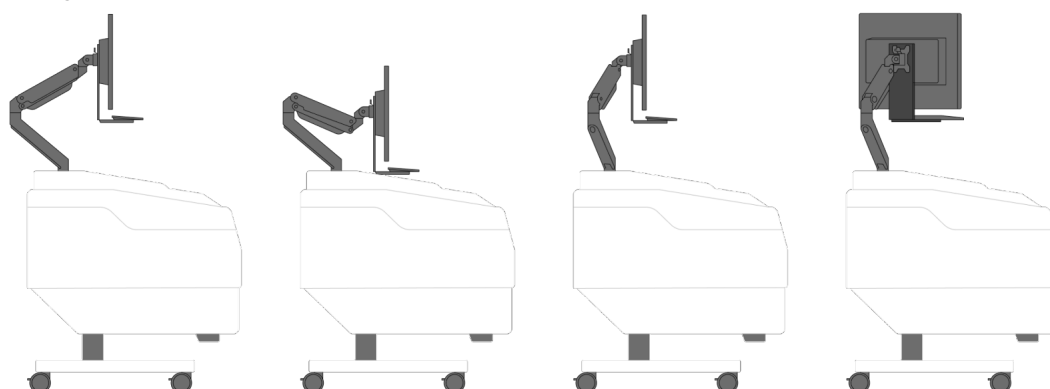

- 5.2.3. To work with the device, the user can use the monitor's touch interface (see page 5 - fig. 3.1, item 1) and the keyboard with a touchpad (see page 5 - fig. 3.1, point 2).
- 5.2.4. Information regarding the ergonomics of the trainee can be found in the educational sections of the Laparo Training Program in the station's computer application.

5.3. Correct operation of training analysis

- 5.3.1. Correct operation of training analysis is only possible when:
- trocars are placed in the ports,
 - all cables are connected: magnetic cables of tools and cameras to instruments HUB (A), USB trocars (B), optical fiber (C), USB camera (D) (see pages 11-16 - points 4.4-4.7).
 - tools used during training are connected to the station with a magnetic quick connector (E).

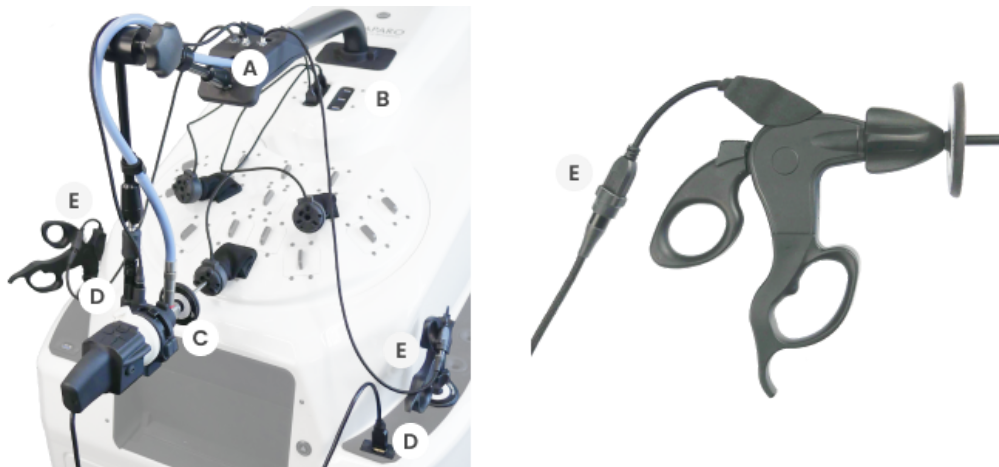

- 5.3.2. The Diathermy Foot Switch (see page 5 - fig. 3.1, item 9) is only used in virtual reality training for cutting and coagulation of tissue.



5.4. Training Modules

- 5.4.1. Laparo Apex PRO is equipped with a number of training modules. Each module can be mounted in the automatic positioning mechanism inside the training area (see page 5 - fig. 3.1, item 8).
- 5.4.2. To open the training area doors, use the door opening button (see page 5 - fig. 3.1, item 12).
- 5.4.3. Use the latch on the front of the robotic cart to attach the training modules. The positioning mechanism will automatically place it in the right position once you start training. Each training scenario has a predefined position and orientation of the training modules.

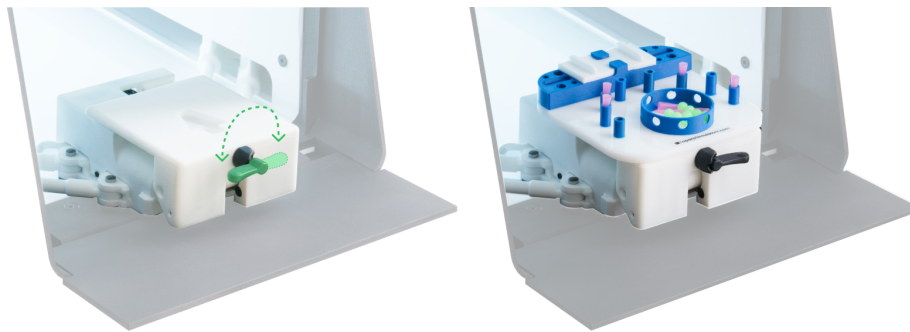

- 5.4.4. To learn more about training modules and the Laparo Training Program, visit the **HELP CENTER** section in the station's computer application.

5.5. Laparoscopic Camera

- 5.5.1. The user can control the **camera setting** while preparing for training (e.g. changing the port) or during training (moving in/out from the port). Each operation related to camera manipulation should be preceded by unscrewing the Magic-Arm knob (see page 8 - fig. 3.4 item 32).
- 5.5.2. For safety reasons, do not unscrew the optical fiber from the laparoscope when the endoscopic light source is turned on. Please make sure it is disabled first.
- 5.5.3. Laparo Apex PRO enables **training with assistance** (cameraman). For this purpose, it is possible to detach the camera from the Magic-Arm camera fixation. It is recommended to perform this operation with two people, where one person holds the camera all the time and the other unplugs it from the station.

To detach the camera from the arm:

- Unscrew the Magic-Arm knob (**A**).
- Disconnect the Quick-Release by first lifting the connector end. (**B-C**).
- and then, while still holding the upper part of the connector, pull it up (**D**).
- Fold the arm (**E**) so that it does not interfere with the camera during further training.
- Tighten the Magic-Arm knob (**F**).

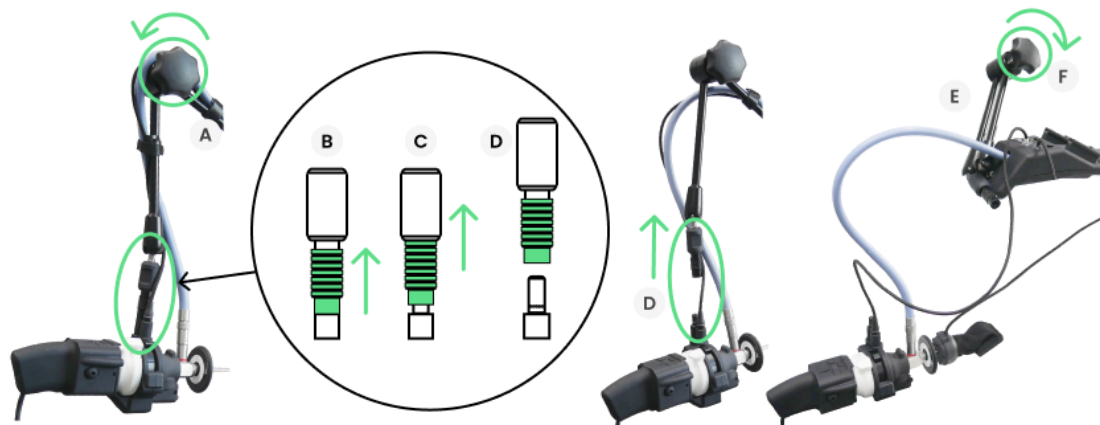

The camera should still be connected to the station using a magnetic cable and a USB cable (see page 15, point 4.6.7) and have a fiber optic screwed on (see page 15, point 4.6.6).

Remember to always connect the camera to Magic-Arm after assisted training (see page 14, point 4.6).

- 5.5.4. Training scenarios may require the use of different types of laparoscopic optics. In this case, it is necessary to **replace the laparoscope**.

When replacing the laparoscope, it is important that the light in the optical fiber is turned off for safety reasons – follow the next steps.

It is also suggested that laparoscope replacement be done with the camera attached to the camera arm (see page 5 – fig. 3.1, item 3, 4).

- Sliding the ocular Quick-Release, unlock the ocular coupler lock **(A)** (see page 8 – fig. 3.4, item 47), and then gently separate the laparoscope from the camera **(B)**. Bring it to the condition shown in the picture:

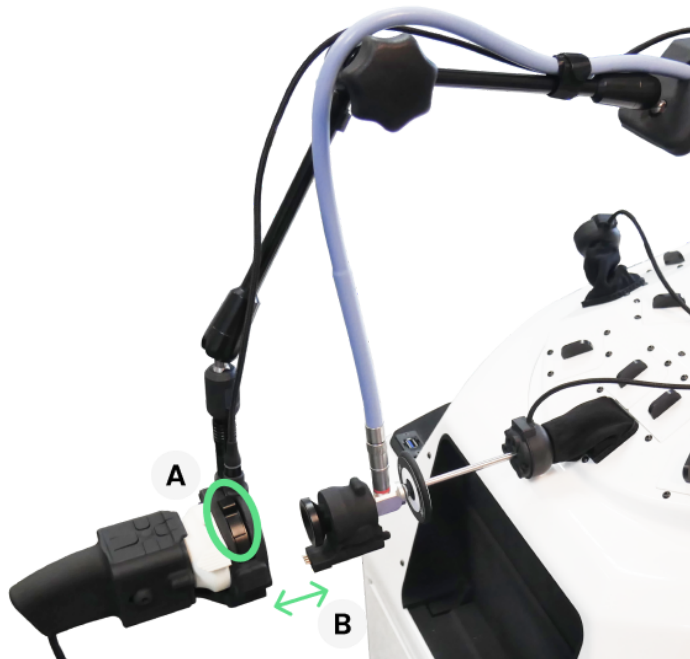

- Unscrew the optical fiber (see page 8 – fig. 3.4, item 40) and pull the laparoscope out of the trocar.
- Insert the second laparoscope into the trocar and screw in the optical fiber.
- Connect the laparoscope to the ocular coupler with the ocular Quick-Release **(A)**.

Note: before mounting another laparoscope, make sure its protective covers have been pulled off (compare with page 13 – fig. 4.5.2). Also make sure that the protective covers have been put on the laparoscope being put away in the storage drawer (compare with page 5 – fig. 3.1, item 8).

- 5.5.5. The laparoscopic camera has a focus ring (**A**) and five function buttons (**B**). The image sharpness can be adjusted by turning the knob both during training on physical training modules and in virtual reality. Function buttons are used to adjust image brightness and use digital magnification.

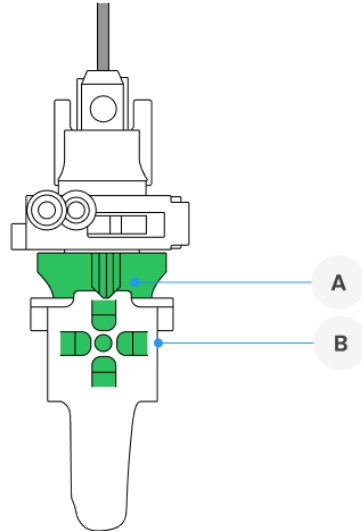

5.6. Laparoscopic instruments

- 5.6.1. To use the full functionality of the device, use only dedicated laparoscopic tools supplied with it. Dedicated laparoscopic tools are equipped with a number of sensors.
- 5.6.2. Improper use of Laparo Apex PRO laparoscopic instruments may damage them. Applying excessive force when opening and closing tools is not recommended.
- 5.6.3. The movable part of the tools (**A**) operates to a limited extent - when the tool tip is closed, do not use excessive force to additionally tighten it.

The knob (**B**) located at the top of the handle allows you to rotate the tip of the tool. It is recommended to use your index finger for this purpose.

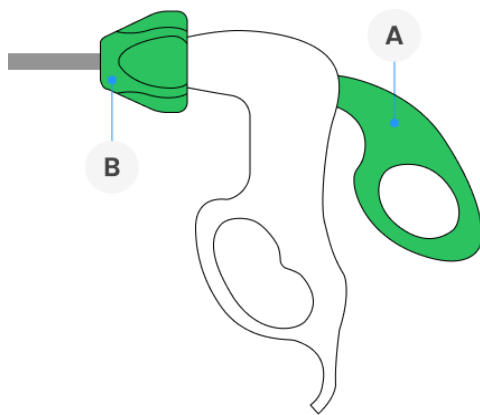

- 5.6.4. The Laparo Apex PRO laparoscopic vice has an automatic locking mechanism that allows you to maintain the selected jaw clamping position. When closing the jaws, you can feel the switching of subsequent mechanism modes. To open the jaws, use the button (**A**). It is recommended to gently press the handle before using the button to ensure smooth unlocking. The jaw locking mechanism can be disabled via the switch (**B**).

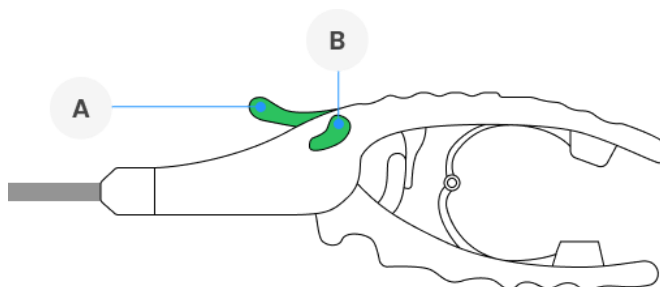

5.6.5. The Laparo Apex PRO set includes two additional tools that are dedicated only to virtual reality training (Multi-Tool 1 and Multi-Tool 2). These instruments do not have jaws and are not used in training with physical training inserts.

5.6.6. **Multi-Tool 1** is used in the simulation of instruments such as: bipolar grasper, vessel sealer, ultrasonic scalpel, stapler.

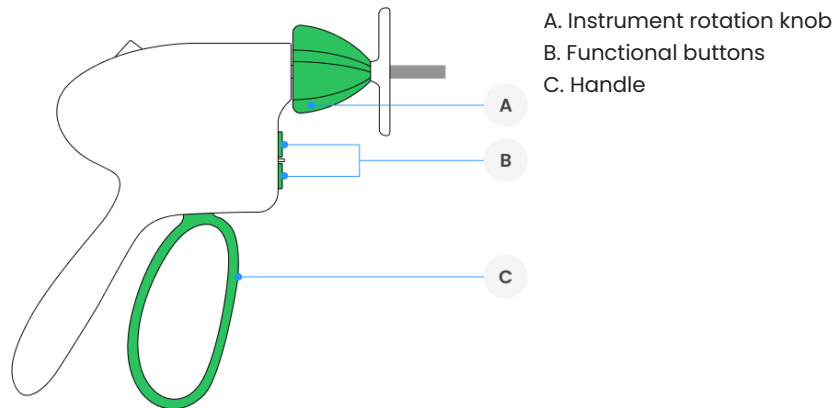

5.6.7. **Multi-Tool 2** is used to simulate the following instruments: monopolar hook, irrigator/suction device.

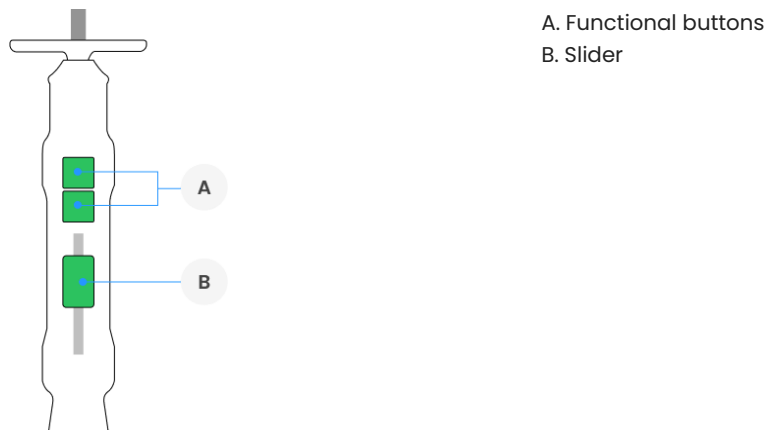

6. PRECAUTIONS AND MAINTENANCE

- 6.1. Always disconnect the device from the mains before cleaning.
- 6.2. Do not use solvent-based cleaning products (e.g. acetone). Chemical substances can permanently damage the device.
- 6.3. Use soft materials for cleaning. If necessary, use a damp microfiber cloth.
- 6.4. Silicone training inserts can be cleaned with warm running water.
- 6.5. The device cannot be exposed to moisture or external weather conditions. It is intended for indoor use.
- 6.6. For greater access to the training area, you can remove the dome. The dome is attached to the station with magnets, so just grab it with two hands and pull it towards you. Before disassembling the dome, remove the camera and instruments from the training field and disconnect the USB cables of the electronic trocars.
- 6.7. When the device is not transported, the wheels should be blocked (see page 4 - point 14).
- 6.8. Lifting of the device is allowed only with the use of the appropriate handles located on the back of the device (A), the 2 side spaces (B) and from the front (C). It is necessary to grasp the device from the bottom in the marked areas to a maximum depth of 8 cm.

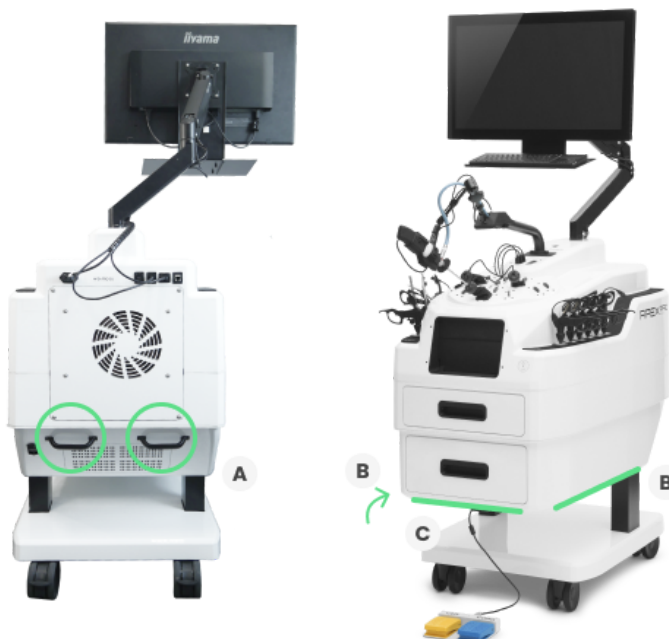

7. TERMS OF WARRANTY

- 7.1. The manufacturer (guarantor) provides a warranty for the Laparo Apex laparoscopic trainer under specific terms.
- 7.2. The warranty covers any product defects resulting from manufacturing defects.
- 7.3. The warranty does not cover product defects resulting from improper use and normal wear and tear.
- 7.4. Making modifications yourself will void the warranty.
- 7.5. Defects discovered during the warranty period will be removed free of charge as soon as possible, not exceeding 21 business days from the date the device is physically accepted for service.
- 7.6. The complaining party is obliged to report the defect to the manufacturer by e-mail or telephone.
- 7.7. The fault must be reported no later than 14 days after its occurrence.
- 7.8. The buyer is obliged to deliver the product in its original packaging, along with all accessories. The buyer is responsible for any damage resulting from the use of substitute packaging.
- 7.9. In the event of an unjustified complaint (complaint about a functional device or when the damage was caused by the customer's fault), the person filing the complaint will be charged with the costs of expertise and transport.
- 7.10. This warranty does not cover product defects resulting from:
 - using the product contrary to its intended use, i.e. use that results in physical or aesthetic damage or damage to the surface of the product or its modifications;
 - infection with a computer virus or use of the product with software other than that supplied with the product or incorrectly installed software;
 - compatibility of devices with which this product is used or incorporated, with the exception of other manufacturer's products intended for use with this product;
 - products of a type, condition and standard other than those recommended by the manufacturer;
 - repairs carried out by persons who are not employees of the manufacturer;
 - negligence, especially dirt;
 - accidents, fire, exposure to liquids or moisture, chemicals or other substances, floods, vibrations, excessive heat, improper ventilation, fluctuations in mains voltage, connection of excessive or incorrect voltage, radiation, electrical discharges including lightning, or any external forces or impacts;
 - mechanically damaged equipment.
- 7.11. The wear and tear of laparoscopic inserts and tools constitutes normal material wear and tear, and therefore the warranty for these elements does not apply, unless the product defect was caused by features inherent in these elements.
- 7.12. The manufacturer reserves the right to replace damaged parts of the product, the entire product or parts of it, with a new or refurbished one.
- 7.13. The buyer loses warranty rights if the nameplate with the serial number is torn off or the manufacturer's service discovers that unauthorized repairs or changes to the system or design of the device have been made.
- 7.14. The Guarantor may refrain from keeping the warranty service on time if unforeseen circumstances of a force majeure nature occur, e.g. natural disaster, social unrest, etc.
- 7.15. The Guarantor is not liable for damages and losses resulting from the inability to use the device under repair.
- 7.16. Warranty rights do not include the buyer's right to claim reimbursement of lost profits due to defects in the device.
- 7.17. The warranty does not exclude, limit or suspend the purchaser's rights under the Act.
- 7.18. The legal relationship between the purchaser of the device and the Guarantor is governed exclusively by the provisions of this warranty. Further claims for damages are excluded unless they result from mandatory provisions of law.

8. TECHNICAL DATA

Dimensions	Min. 620 x 1000 x 1420 mm Max. 620 x 1080 x 2110 mm
Power	100-240V~ 50/60Hz 900W
Light sources	1. Light source power: 76W 2. Panel LED power: 48W
Camera	Maksymalna rozdzielczość: 1920 x 1080 px
Weight	115 kg

Manufacturer:

Laparo Sp. z o. o.

Wilcza 25c st.

50-429 Wrocław

Poland

VAT no: PL8971818380

www.laparosimulators.com

office@laparosimulators.com